

THE TITAN RANGE

Heavy Duty Commercial Umbrellas



AWNING
REPUBLIC

THE TITAN RANGE

Superior materials, design and construction combine to create an umbrella able to withstand the harshest conditions.













Option for 100% Acrylic Canvas or PVC Coated Polyester canopies with 99% sun blackout.

Powder coated aluminium frames offer strength and durability. Coupled with a 5 year warranty.

Bolt-down or in-ground fixings available.

Wind ratings up to 80km/hr when open*

* 80km/hr wind rating is based on 6m octagonal tests while open.

			
Umbrella Specifications	3m Square	3.6m Square	4m Square
Coverage	8.0m ²	12.96m ²	18.0m ²
Wind Rating (Open)	80 km/hr	80 km/hr	80 km/hr
			
Umbrella Specifications	4.5m Square	4.8m Square	3m Octagon
Coverage	20.25m ²	23.34m ²	5.88m ²
Wind Rating (Open)	80 km/hr	80 km/hr	80 km/hr
			
Umbrella Specifications	3.5m Octagon	4m Octagon	4.5m Octagon
Coverage	8.73m ²	11.55m ²	14.4m ²
Wind Rating (Open)	80 km/hr	80 km/hr	80 km/hr
			
Umbrella Specifications	5m Octagon	5.5m Octagon	6m Octagon
Coverage	17.5m ²	21.45m ²	21.46m ²
Wind Rating (Open)	80 km/hr	80 km/hr	80 km/hr



High Strength, Low Maintenance



Fixed or Retractable



Sizes to Suit Any Area



Acrylic Canvas or PVC Coated Polyester Canopies Available

Standard Colour Options



32 Fabric Colours Available

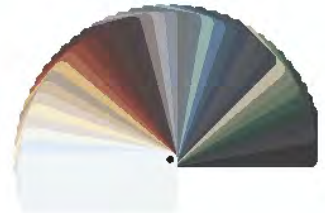

10 Frame Colours Available



Unit 12/108 Welshpool Road, Welshpool, WA

6106 (08) 9361 2728

www.awningrepublic.com.au

sales@awningrepublic.com.au



AWNING
REPUBLIC

THE TITAN RANGE

CE OCTAGONAL								
size	A	B	C	D	E	F	G	H
3.5	2300	2850	3200	3500	1350	3650	1800	400
4.0	2300	2950	3700	4000	1500	3750	1650	400
4.5	2300	3000	4150	4500	1750	3900	1500	450
5.0	2400	3250	4550	5000	1900	4050	1450	450
5.5	2350	3200	5100	5500	2100	4100	1200	500
6.0	2400	3250	5450	6000	2300	4150	1050	500

* A & G is without valance. Subtract 200mm for dimensions with valance.

** To be used as a guide only. All measurements are approximate.

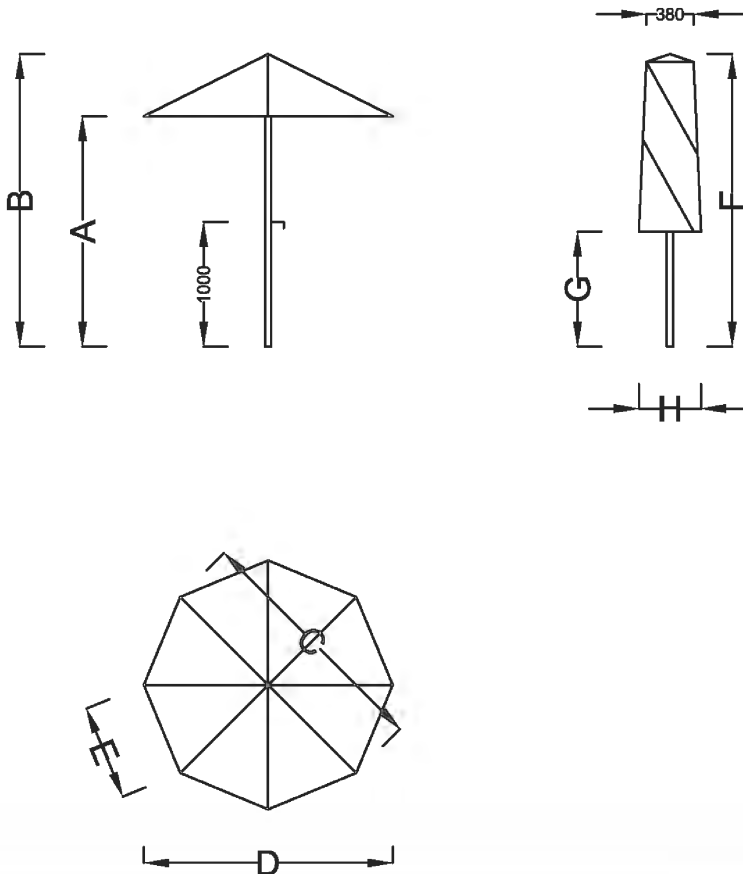

Unit 12/108 Welshpool Road, Welshpool, WA 6106

(08) 9361 2728

www.awningrepublic.com.au

sales@awningrepublic.com.au



AWNING
REPUBLIC

THE TITAN RANGE

CE SQUARE								
size	A	B	C	D	E	F	G	H
2.5	2350	2850	2500	3550	1250	3600	1750	400
2.8	2300	2850	2830	4050	1415	3600	1550	400
2.9	2250	2850	2960	4200	1480	3600	1450	400
3.0	2250	2900	3060	4350	1530	3600	1350	400
3.6	2300	2950	3670	5100	1835	3700	1050	450
4.0	2300	3100	4000	5600	2000	4000	1100	450
4.5	2350	3250	4400	6200	2200	4150	900	500
4.8	2300	3300	4700	6600	2350	4150	700	500

* A & G is without valance. Subtract 200mm for dimensions with valance.

** To be used as a guide only. All measurements are approximate.

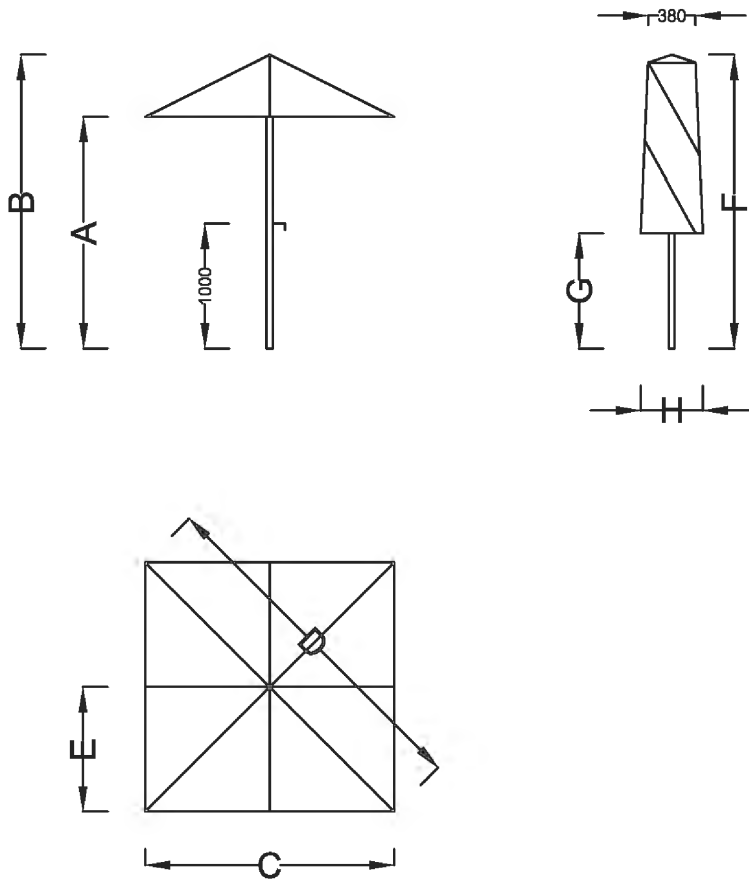

Unit 12/108 Welshpool Road, Welshpool, WA 6106

(08) 9361 2728

www.awningrepublic.com.au

sales@awningrepublic.com.au



AWNING
REPUBLIC

THE TITAN RANGE

Acrylic Fabric colour samples

Canopies are made from the most advanced outdoor awning fabrics. 100% Acrylic Canvas, 99% sun block, Water resistant, Designed for outdoor use, Mould & mildew resistant, Fade resistant, U.V. ray reflective, Extensive range of colours.

Colours shown are for illustrative purposes only.



Ferrari '502' PVC Coated Polyester samples

(Commercial Range only) has all of the features listed above, but is: 100% sun block, Water proof.

Colours shown are for illustrative purposes only.

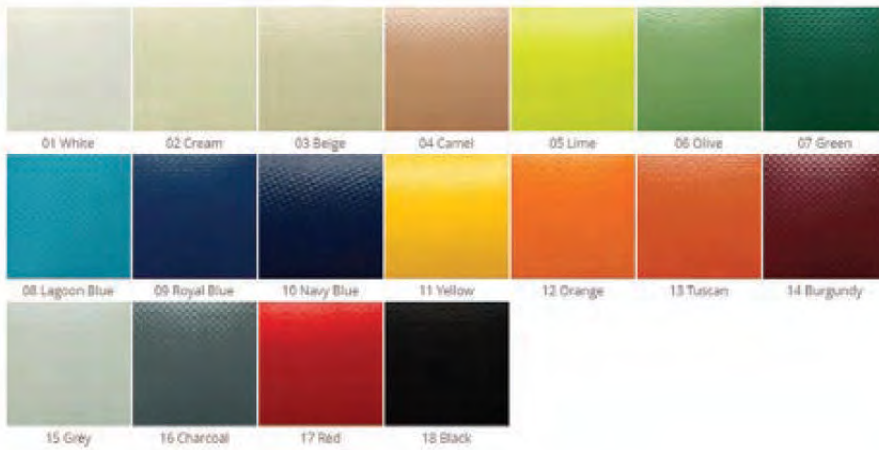

Powder Coated Aluminium Frame samples

10 Standard colours + custom colours upon request.

Colours shown are for illustrative purposes only.

